

Giunti ad innesto rapido Serie 5000

Diametri nominali: 5, 7 mm - Filetti dei giunti: G1/8, G1/4, G3/8, G1/2
 Tubi di plastica: 6/4, 8/6, 10/8
 Tubi di gomma: 6x14, 8x17, 10x19, 13x23



I giunti ad innesto rapido della Serie 5000 sono ideali in situazioni dove, per ragioni impiantistiche o di sicurezza, è necessario connettere o disconnettere frequentemente i collegamenti di un impianto. Tale operazione viene effettuata senza dover scaricare la pressione, permettendo quindi un notevole risparmio di tempo.

I giunti ad Innesto rapido Serie 5000 con profilo Mini DN 5 sono compatibili con i giunti Rectus Serie 21 - 90, Legris 21. I giunti ad Innesto rapido Serie 5000 con profilo Europeo DN 7 sono compatibili con i giunti Cejn Serie 320.

CARATTERISTICHE GENERALI

Gruppo valvola	rubinetto rapido automatico
Costruzione	a otturatore
Fissaggio	a mezzo filetto
Filettature	GAS cilindrico ISO 228 (BSP)
Materiali	OT nichelato (acciaio cementato e zincato solo per innesti con terza cifra 8 nel codice) guarnizioni NBR
Attacchi	G1/8 - G1/4 - G3/8 - G1/2 - per tubo plastica e tubo gomma
Temperatura d'esercizio	0°C ÷ 80°C (con aria secca - 20°C)
Pressione d'esercizio	- 0,99 ÷ 12 bar
Pressione nominale	6 bar
Portata nominale	vedi grafico
Diametro nominale	ø5 - ø7
Fluido	aria compressa e altri fluidi a bassa pressione

Giunti ad innesto rapido



Diagramma della portata

Il diagramma qui riportato serve per dare un'indicazione all'utilizzatore circa il modello da usare in rapporto alla pressione di lavoro ed alla portata necessaria. Le misurazioni sono state effettuate con i modelli seguenti indicati e sono la condizione ideale di massima portata. Qualora si debbano usare tubi inferiori, si dovrà tenere conto di un minor rendimento.

Q (NL/min) = portata
 Δp (bar) = variazione di pressione

P_a (bar) = pressione d'ingresso

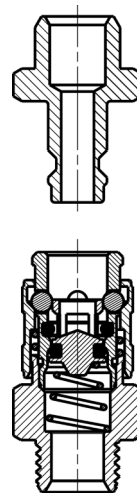
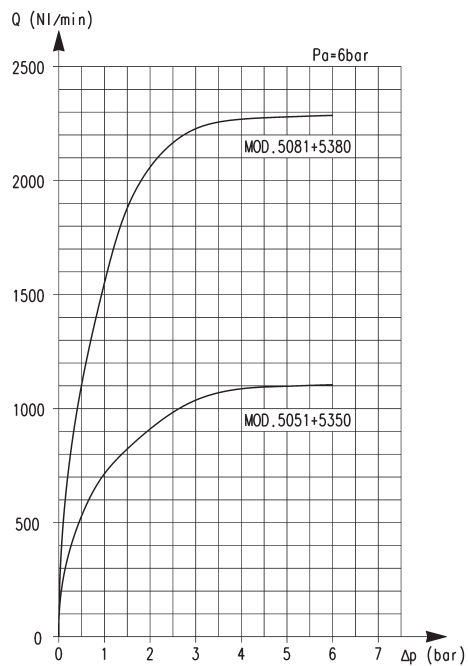

Raccordi Mod. 5051 Serie Mini e Mod. 5081 Standard Europeo



Giunto Maschio Cilindrico

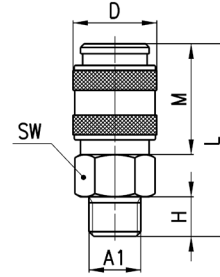

DIMENSIONI								
Mod.	A1	∅	D	H	L	M	SW	Peso (g)
5051 1/8	G1/8	5	17	6	35	20,5	14	28
5051 1/4	G1/4	5	17	8	37	20,5	17	37
5081 1/4	G1/4	7	25	8	47,5	34,5	22	93
5081 3/8	G3/8	7	25	9	48,5	34,5	22	92
5081 1/2	G1/2	7	25	10	49,5	34,5	24	107



Raccordi Mod. 5052 Serie Mini e Mod. 5082 Standard Europeo



Giunto Maschio Passaparete Cilindrico

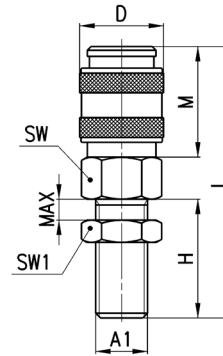

DIMENSIONI										
Mod.	A1	∅	D	H	L	M	max	SW	SW1	Peso (g)
5052 1/8	G1/8	5	17	23	52	20,5	12	14	14	38
5052 1/4	G1/4	5	17	24	53	20,5	12	17	17	52
5082 1/4	G1/4	7	25	24	63,5	34,5	12	22	17	103



Raccordi Mod. 5053 Serie Mini e Mod. 5083 Standard Europeo



Giunto Femmina Cilindrico

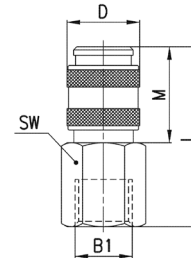

DIMENSIONI								
Mod.	B1	∅	D	L	M	SW	Peso (g)	
5053 1/8	G1/8	5	17	37,5	20,5	14	33	
5053 1/4	G1/4	5	17	39,5	20,5	17	44	
5083 1/4	G1/4	7	25	47,5	34,5	17	88	
5083 3/8	G3/8	7	25	49	34,5	20	93	
5083 1/2	G1/2	7	25	53	34,5	24	103	



Raccordi Mod. 5054 Serie Mini e Mod. 5084 Standard Europeo



Giunto a Calzamento

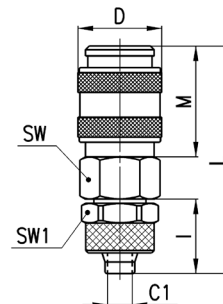

DIMENSIONI										
Mod.	Tubo	∅	C1	D	I	L	M	SW	SW1	Peso (g)
5054 6/4	6/4	5	3	17	15	44	20,5	14	12	36
5054 8/6	8/6	5	5	17	15	44	20,5	14	14	38
5084 8/6	8/6	7	5	25	15	54,5	34,5	22	14	99
5084 10/8	10/8	7	6,5	25	16,5	56	34,5	22	16	103



Raccordi Mod. 5055 Serie Mini



Giunto Passaparete a Calzamento

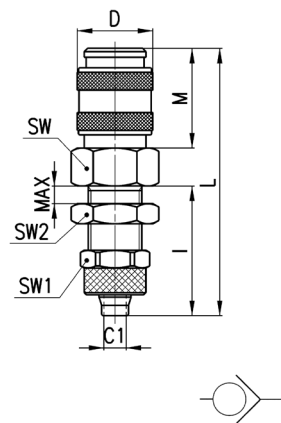

DIMENSIONI												
Mod.	Tubo	∅	C1	D	I	L	M	Max	SW	SW1	SW2	Peso (g)
5055 6/4	6/4	5	3	17	29	58	20,5	10	14	12	14	44
5055 8/6	8/6	5	5	17	29	58	20,5	11	17	14	17	52

Raccordi Mod. 5056 Serie Mini e Mod. 5086 Standard Europeo



Giunto a Resca

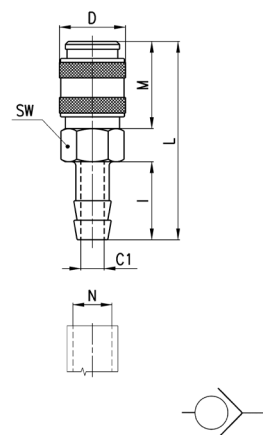

DIMENSIONI									
Mod.	N	∅	C1	D	I	L	M	SW	Peso (g)
5056 06	6	5	3	17	20	49	20,5	14	30
5056 09	9	5	5	17	20	49	20,5	14	32
5086 09	9	7	5	25	20	59,5	34,5	22	95
5086 12	12	7	8	25	20	59,5	34,5	22	96

Raccordi Mod. 5057 Serie Mini e Mod. 5087 Standard Europeo



Giunto Portagomma

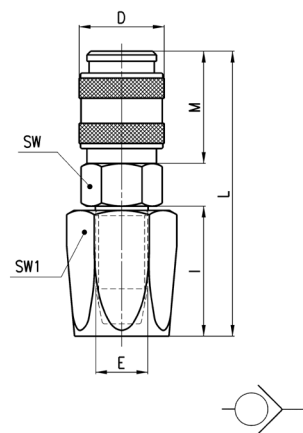

DIMENSIONI										
Mod.	Tubo	∅	E	D	I	L	M	SW	SW1	Peso (g)
5057 6x14	6 x 14	5	9	17	25	54,5	20,5	17	17	62
5087 6x14	6 x 14	7	9	25	25	64,5	34,5	22	17	117
5087 8x17	8 x 17	7	10	25	25	64,5	34,5	22	19	123
5087 10x19	10 x 19	7	12	25	27	66,5	34,5	22	22	141
5087 13x23	13 x 23	7	15	25	37	76,5	34,5	22	27	195

Raccordi Mod. 5058 Serie Mini e Mod. 5088 Standard Europeo



Giunto con Molla

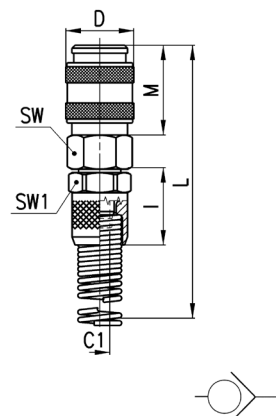

DIMENSIONI										
Mod.	Tubo	∅	C1	D	I	M	L	SW	SW1	Peso (g)
5058 6/4	6/4	5	3	17	19	20,5	120,5	14	14	48
5058 8/6	8/6	5	5	17	19	20,5	124,5	14	14	54
5088 8/6	8/6	7	5	25	19	34,5	135	22	14	118
5088 10/8	10/8	7	6,5	25	21,5	34,5	139,5	22	16	125

Raccordi Mod. 5150 Profilo Mini e Mod. 5180 Profilo Europeo



Innesto Maschio

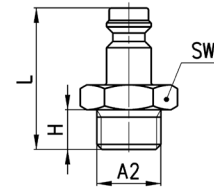

DIMENSIONI						
Mod.	A2	∅	H	L	SW	Peso (g)
5150 1/8	G1/8	5	6	26	13	12
5150 1/4	G1/4	5	8	28,5	17	19
5180 1/4	G1/4	7	8	33	17	21
5180 3/8	G3/8	7	9	34	19	26
5180 1/2	G1/2	7	10	35,5	24	34

Raccordi Mod. 5350 Profilo Mini e Mod. 5380 Profilo Europeo



Innesto Femmina

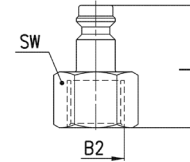

DIMENSIONI						
Mod.	B2	∅	L	SW	Peso (g)	
5350 1/8	G1/8	5	25,5	13	14	
5350 1/4	G1/4	5	27,5	17	18	
5380 1/4	G1/4	7	31,5	17	21	
5380 3/8	G3/8	7	32,5	19	23	
5380 1/2	G1/2	7	36,5	24	37	

Raccordi Mod. 5450 Profilo Mini e Mod. 5480 Profilo Europeo



Innesto a Calzamento

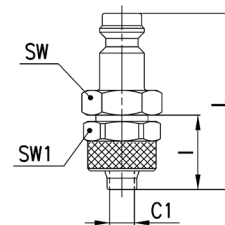

DIMENSIONI								
Mod.	Tubo	∅	C1	I	L	SW	SW1	Peso (g)
5450 6/4	6/4	5	3	15	35	12	12	17
5450 8/6	8/6	5	5	15	35	13	14	22
5480 8/6	8/6	7	5	15	39,5	14	14	25
5480 10/8	10/8	7	6,5	16,5	41,5	17	16	33

Raccordi Mod. 5650 Profilo Mini e Mod. 5680 Profilo Europeo



Innesto a Calzamento

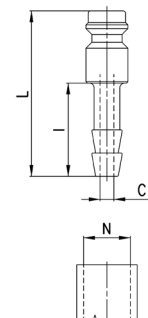

DIMENSIONI						
Mod.	N	∅	C1	I	L	Peso (g)
5650 06	6	5	3	20	35,5	8
5650 09	9	5	5	20	35,5	11
5680 06	6	7	3	20	40	14
5680 09	9	7	5	20	40	15
5680 12	12	7	7	20	40	19

Raccordi Mod. 5750 Profilo Mini e Mod. 5780 Profilo Europeo



Innesto Portagomma

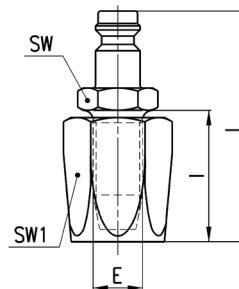

DIMENSIONI								
Mod.	Tubo	∅	E	I	L	SW	SW1	Peso (g)
5750 6x14	6 X 14	5	9	25	45	14	17	40
5780 6x14	6 X 14	7	9	25	50	14	17	44
5780 8x17	8 X 17	7	10	25	50	14	19	50
5780 13x23	13 X 23	7	15	37	62	19	27	123

Raccordi Mod. 5850 Profilo Mini e Mod. 5880 Profilo Europeo



Innesto con Molla

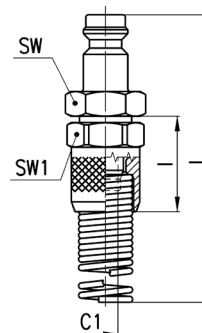

DIMENSIONI								
Mod.	Tubo	∅	C1	I	L	SW	SW1	Peso (g)
5850 6/4	6/4	5	3	19	111,5	12	12	27
5850 8/6	8/6	5	5	19	116	14	14	40
5880 8/6	8/6	7	5	19	120	14	14	44
5880 10/8	10/8	7	6,5	21,5	125	17	16	55